

# PH03 Comfort XL™ Front Assembly Replacement Instructions

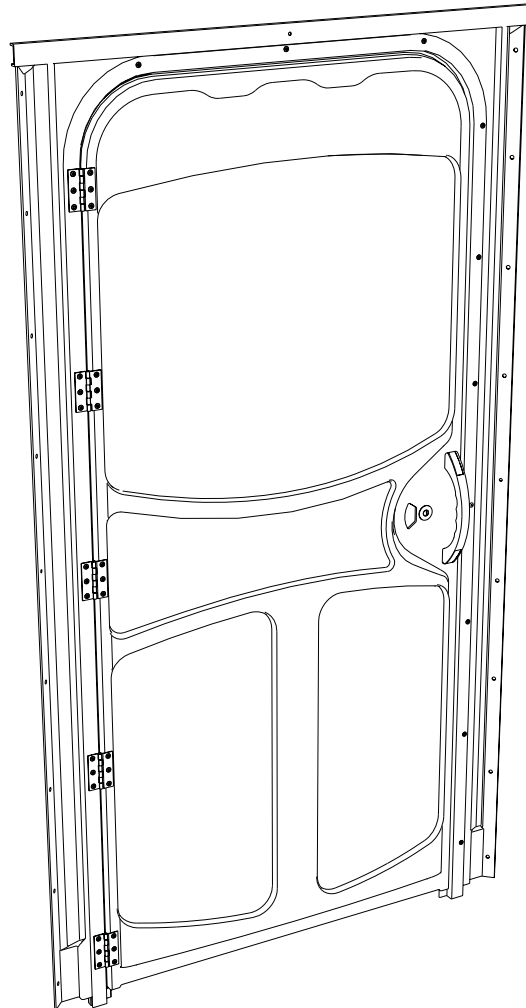

## **POLYJOHN USA**

PolyJohn Enterprises Corp  
2500 Gaspar Ave.  
Whiting, IN 46394  
Phone: 800-292-1305  
Fax: 219-659-0625  
[www.polyjohn.com](http://www.polyjohn.com)  
[info@polyjohn.com](mailto:info@polyjohn.com)

## **POLYJOHN WORLDWIDE**

PolyJohn (UK) Ltd.  
Equinox 1 Audby Lane  
Wetherby, England LS22 7RD  
Phone: 44 (0) 1937-583333  
Fax: 44 (0) 1937-583322  
[sales@polyjohn.co.uk](mailto:sales@polyjohn.co.uk)

## **POLYJOHN CANADA**

PolyJohn Canada  
P.O. Box 2300  
199 Forest Plain Rd.  
Orillia, Ontario LV3 6S2  
Phone: 800-465-9590  
Fax: 705-325-8250  
[info@polyjohncanada.ca](mailto:info@polyjohncanada.ca)

# PH03-0003 Front Assembly

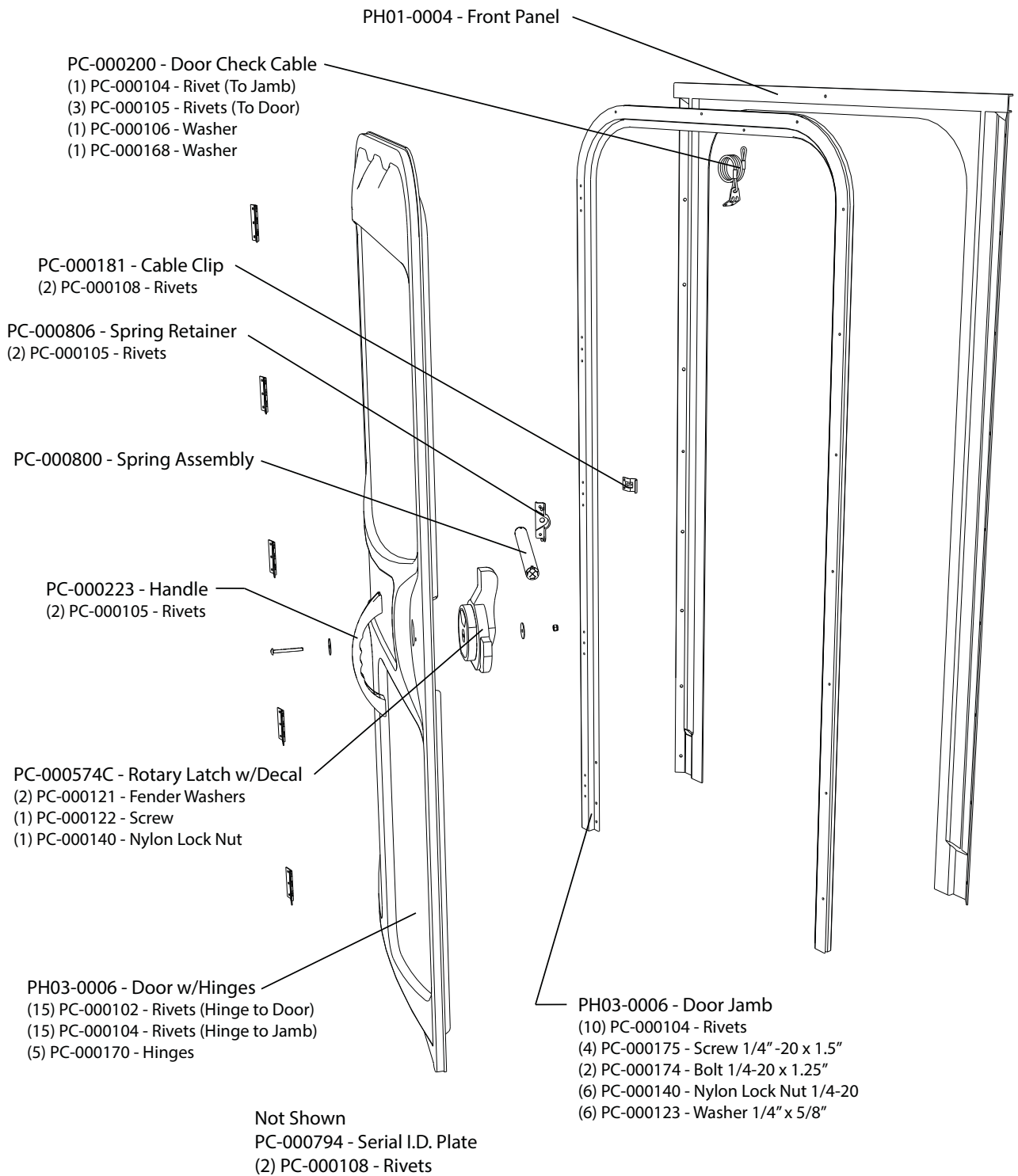

## GENERAL OVERVIEW

- Please follow directions in the sequence they are presented. It is suggested you read through the entire assembly instructions prior to proceeding.
- Proper handling is required, especially structures that have flat floors with minimal foundations. Dropping this unit during transport and site set-up may cause structural damage or misalignment of the front assembly and door.
- Position on clear level ground, shims may be used under the floor to aid in leveling, or the door may be out of alignment.
- The **PH03 Model** restroom assembly will require two people.
- All drilling with 13/64" and 1/4" drill bits. All rivet holes drilled 13/64" dia.
- All references to left, right, front and rear throughout the entire assembly instructions are as viewed from the front of the restroom.

### ~~Tools Required for Assembly~~

- |                              |                             |                               |
|------------------------------|-----------------------------|-------------------------------|
| • 13/64" Drill Bit           | • 7/16" Wrench              | • Vise-Grips (Locking Pliers) |
| • Rivet Gun 3/16" nose piece | • Ratchet with 7/16" Socket | • Hammer                      |
| • Phillips Screwdriver       | • Standard Screwdriver      |                               |

## FULL SIZE SCALE FASTENER DRAWINGS

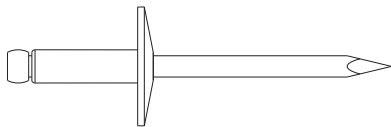

(23) PC-000100 Rivet  
Large Flange, Short

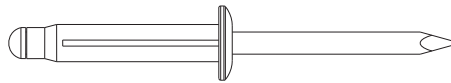

(7) PC-000105 Rivet  
Small Flange

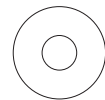

(24) PC-000106  
Washer  
3/16" Back-up

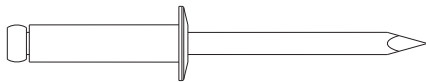

(1) PC-000104 Rivet  
Small Flange, Long

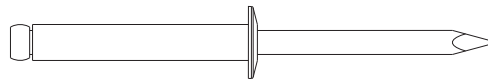

(1) PC-000107 Rivet  
Small Flange, Extra Long

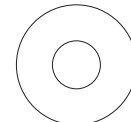

(6) PC-000123 Washer  
1/4" x 5/8" Flat

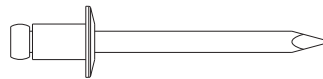

(2) PC-000108 Rivet  
Small Flange, Extra Short

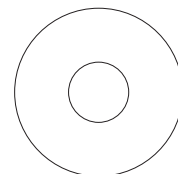

(1) PC-000168 Washer  
5/16" x 7/16" Flat

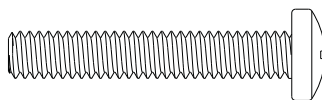

(4) PC-000175 Screw  
1/4"-20 x 1-1/2" Phillips

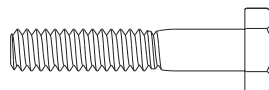

(2) PC-000174 Bolt  
1/4"-20 x 1-1/4" Hex Head

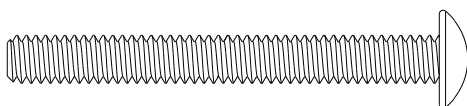

(1) PC-000122 Screw  
1/4"-20 x 2-1/4" TrussHead



(1) PC-000140  
Nut 1/4"-20 Nylok

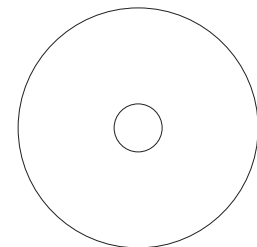

(2) PC-000121 Washer  
1/4" x 1-1/4" Fender

# ASSEMBLY INSTRUCTIONS

## Step 1. Remove the existing front assembly

Remove the bolts that are holding the door jamb to the base surround using a ratchet with a 7/16" socket and a 7/16" wrench for the top bolt and a Phillips screwdriver with a 7/16" wrench for the bottom two. Drill out the rivets that are holding the front assembly to the unit by using a drill with a 13/64" drill bit and a pair of locking pliers. Lock the pliers on the back side of the rivet (where the backup washer is) and then drill out the head of the rivet. Do this for all the rivets that are holding the front assembly to the unit.

## Step 2. Front Sub-Assembly to the Base Surrounds

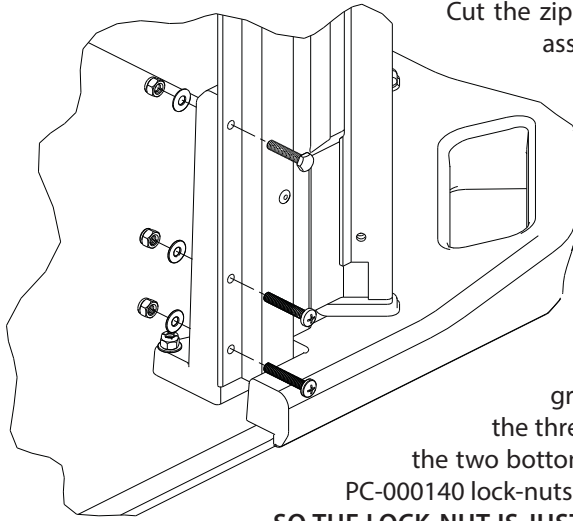

Cut the zip tie that holds the door closed during shipping and lift the front assembly up and under the roof. In order to get the legs of the aluminum door jamb into the "pockets" of the base surround on each side of the door opening, you may have to open the door slightly, and swing the end of the jamb into the base surround. Attach the front assembly to the front corner moldings by riveting into the pre-drilled holes using (18) PC-000100 rivets and (18) PC-000106 back-up washers. **NOTE:** (Make sure that you rivet from the outside of the front toward the corner.) Install a PC-000107 rivet into the hole in the door jamb that the zip tie went into. Grab one side of the front assembly and pull tightly into the "pocket" of the base surround and place a pair of vise-grips onto the base surround holding the front sub-assembly. Locate the three pre-drilled holes in the bottom of the door jamb, and insert into the two bottom holes (2) PC-000175 screws with (2) PC-000123 washers with (2) PC-000140 lock-nuts. **DO NOT TIGHTEN TO THE END OF THE THREAD, TIGHTEN JUST SO THE LOCK-NUT IS JUST FLUSH AT THE END OF THE SCREW.** Insert into the top hole (1) PC-000174 bolt with (1) PC-000123 washer and (1) PC-000140 lock-nut. **DO NOT TIGHTEN TO THE END OF THE THREAD, TIGHTEN JUST SO THE LOCK-NUT IS JUST FLUSH AT THE END OF THE SCREW.** Repeat this for the other side of the front sub-assembly. Rivet the roof in place using the PC-000100 rivets from the outside with PC-000106 washers on the inside.

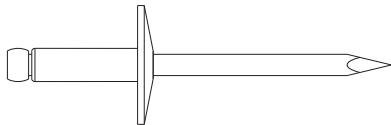

PC-000100 Rivet  
18 Used in this step

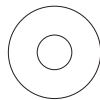

PC-000106 Washer  
18 Used in this step

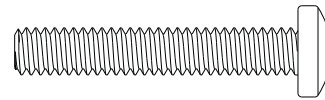

PC-000175 Screw  
4 Used in this step

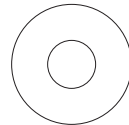

PC-000123 Washer  
6 Used in this step

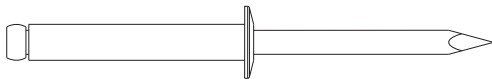

PC-000107 Rivet  
1 Used in this step

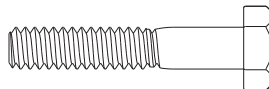

PC-000174 Bolt  
2 Used in this step



PC-000140 Nut  
6 Used in this step

### Step 10. Door Handle and Rotary Latch

Mark the hole locations on the front of the door for the door handle by measuring up from the bottom of the door by 31-1/2" and measuring in from the side of the door by 1". This is the location for the bottom mounting hole. Using a drill with a 13/64" drill bit, drill a hole through ONLY THE OUTSIDE WALL of the door. Rivet the door handle to the door using a PC-000105 rivet through the bottom hole of the handle. Making sure the handle is straight on the door, use the very top hole of the handle as a drill guide and drill a 13/64" hole through only the outside wall of the door. Rivet in place using a PC-000105 rivet. To mount the rotary latch, insert the PC-000122 Screw through a PC-000121 washer and into the front of the door. Place the rotary latch, another PC-000121 washer on the end of the screw and fasten in place using a PC-000140 lock nut. Adjust the tightness of the screw to adjust the ease of the latch movement.

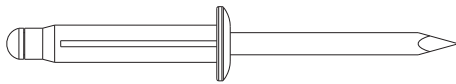
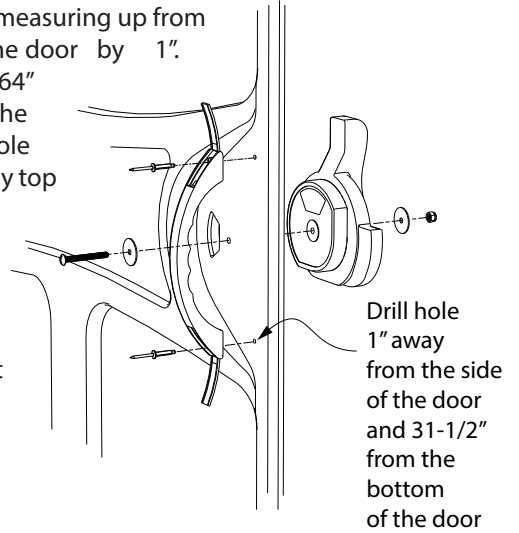

PC-000105 Rivet  
2 Used in this step

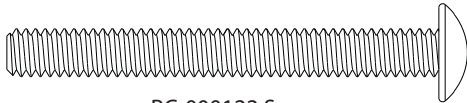

PC-000122 Screw  
1 Used in this step

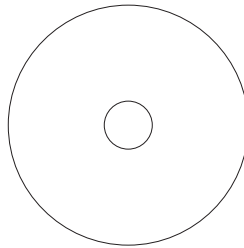

PC-000121 Washer  
2 Used in this step

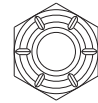

PC-000140 Nut  
1 Used in this step

### Step 11. Door Check Cable

Align the three holes of the metal bracket on the door check cable to the holes in the top inside center of the door so that the bracket angles toward the unit and the three holes line up with the holes in the bracket (as shown). Rivet into place using (3) PC-000105 rivets. From the outside of the unit, insert a PC-000104 rivet into the pre-drilled hole at the top of the door opening of the door jamb. Place the looped end of the door check cable on the end of the rivet followed by (1) PC-000168 washer and (1) PC-000106 back-up washer. Rivet in place.

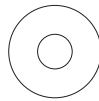
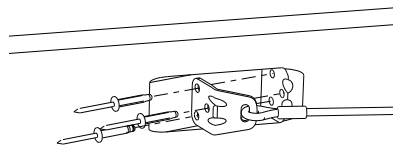

PC-000106 Washer  
1 Used in this step

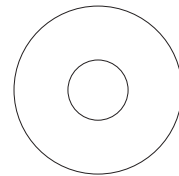

PC-000168 Washer  
1 Used in this step

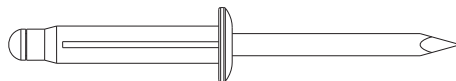

PC-000105 Rivet  
3 Used in this step

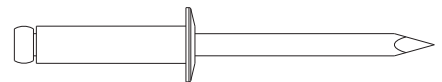

PC-000104 Rivet  
1 Used in this step

### Step 14. Door Closure Installation

Push the spring tube assembly into the hole in the center molded pocket of the door with the swaged ball end towards the hinged side of the door. Insert the tabs of the door closure retainer clip into the 2 pre-drilled holes as shown below. Pivot the retainer clip into place while feeding the spring cable through the hole in the retainer clip. Rivet into place with (2) PC-000105 rivets. Line up the cable clip in the center of the door jamb to the door closure retainer clip. From inside the unit using a 13/64" bit, drill two holes into one side of the door jamb only. Rivet the cable clip to the door jamb using (2) PC-000108 rivets. On the inside of the unit, place the top of a hammer against the cable clip. Place the ball end of the spring cable in the claw of the hammer. Open the door while holding the hammer in position. Hold the door open with your foot and clamp a vice-grip pliers on the cable where it comes out of the door. **BE SURE TO CLAMP DOWN TIGHT.** Remove the cable from the claw of the hammer, close the door and place the end of the cable into the slot of the cable clip. Open the door and remove the vice-grips.

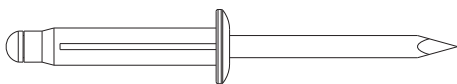
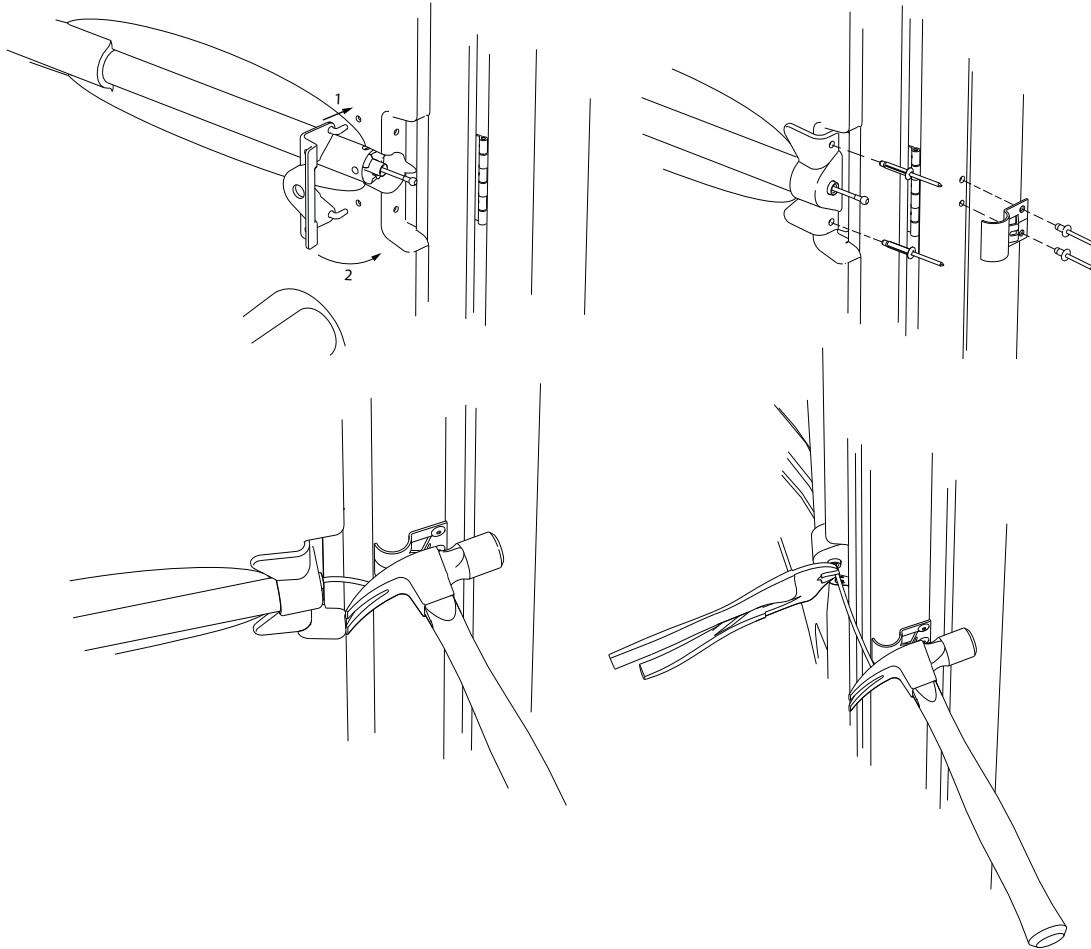

PC-000105 Rivet  
2 Used in this step



PC-000108 Rivet  
2 Used in this step

Assembly is complete